

ONKYO®

Remote Interactive Dock

DS-A4

Instruction Manual

Thank you for purchasing an Onkyo product. Please read this manual carefully before making any connections or using this product. By following these instructions, you'll get the best audio performance and the most listening pleasure from your Onkyo product. Keep this manual for future reference.

Made for



iPod



iPhone

iPhone, iPod, iPod classic, iPod nano, iPod shuffle, and iPod touch are trademarks of Apple Inc., registered in the U.S. and other countries.

"Made for iPod" and "Made for iPhone" mean that an electronic accessory has been designed to connect specifically to iPod or iPhone, respectively and has been certified by the developer to meet Apple performance standards. Apple is not responsible for the operation of this device or its compliance with safety and regulatory standards.

Please note that the use of this accessory with iPod or iPhone may affect wireless performance.

Contents

Important Safety Instructions 2

Precautions 2

Getting Started 4

About the RI Dock 4

Features 4

Package Contents 4

Getting to Know the RI Dock 5

Remote Controller 6

Hooking Up the RI Dock 8

Using the RI Dock 9

Setting the OSD Mode 9

Controlling Your iPod/iPhone without
the OSD 9

Controlling Your iPod/iPhone with
the OSD 9

Music Mode 9

Video Mode 11

Resume Function 11

Setting the TV System (European
model only) 12

Other Functions 12

Setting the Remote Controller's ID. . . 13

Using Your Amp's Remote Controller . . 14

Troubleshooting 15

Specifications 15



WARNING:

TO REDUCE THE RISK OF FIRE OR ELECTRIC SHOCK, DO NOT EXPOSE THIS APPARATUS TO RAIN OR MOISTURE.

CAUTION:

TO REDUCE THE RISK OF ELECTRIC SHOCK, DO NOT REMOVE COVER (OR BACK). NO USER-SERVICEABLE PARTS INSIDE. REFER SERVICING TO QUALIFIED SERVICE PERSONNEL.



WARNING
RISK OF ELECTRIC SHOCK
DO NOT OPEN

AVIS
RISQUE DE CHOC ELECTRIQUE
NE PAS OUVRIR



The lightning flash with arrowhead symbol, within an equilateral triangle, is intended to alert the user to the presence of uninsulated "dangerous voltage" within the product's enclosure that may be of sufficient magnitude to constitute a risk of electric shock to persons.



The exclamation point within an equilateral triangle is intended to alert the user to the presence of important operating and maintenance (servicing) instructions in the literature accompanying the appliance.

Important Safety Instructions

1. Read these instructions.
2. Keep these instructions.
3. Heed all warnings.
4. Follow all instructions.
5. Do not use this apparatus near water.
6. Clean only with dry cloth.
7. Do not block any ventilation openings. Install in accordance with the manufacturer's instructions.
8. Do not install near any heat sources such as radiators, heat registers, stoves, or other apparatus (including amplifiers) that produce heat.
9. Do not defeat the safety purpose of the polarized or grounding-type plug. A polarized plug has two blades with one wider than the other. A grounding type plug has two blades and a third grounding prong. The wide blade or the third prong are provided for your safety. If the provided plug does not fit into your outlet, consult an electrician for replacement of the obsolete outlet.
10. Protect the power cord from being walked on or pinched particularly at plugs, convenience receptacles, and the point where they exit from the apparatus.
11. Only use attachments/accessories specified by the manufacturer.
12. Unplug this apparatus during lightning storms or when unused for long periods of time.

13. Refer all servicing to qualified service personnel. Servicing is required when the apparatus has been damaged in any way, such as power-supply cord or plug is damaged, liquid has been spilled or objects have fallen into the apparatus, the apparatus has been exposed to rain or moisture, does not operate normally, or has been dropped.
14. **Damage Requiring Service**
Unplug the apparatus from the wall outlet and refer servicing to qualified service personnel under the following conditions:
 - A. When the power-supply cord or plug is damaged,
 - B. If liquid has been spilled, or objects have fallen into the apparatus,
 - C. If the apparatus has been exposed to rain or water,
 - D. If the apparatus does not operate normally by following the operating instructions. Adjust only those controls that are covered by the operating instructions as an improper adjustment of other controls may result in damage and will often require extensive work by a qualified technician to restore the apparatus to its normal operation,
 - E. If the apparatus has been dropped or damaged in any way, and
 - F. When the apparatus exhibits a distinct change in performance this indicates a need for service.

Precautions

1. **Recording Copyright**—Unless it's for personal use only, recording copyrighted material is illegal without the permission of the copyright holder.
2. **Care**—Occasionally you should dust the unit all over with a soft cloth. For stubborn stains, use a soft cloth dampened with a weak solution of mild detergent and water. Dry the unit immediately afterwards with a clean cloth. Don't use abrasive cloths, thinners, alcohol, or other chemical solvents, because they may damage the finish or remove the panel lettering.
3. **Never Touch this Unit with Wet Hands**—Never handle this unit or its power cord while your hands are wet or damp. If water or any other liquid gets inside this unit, have it checked by your Onkyo dealer.

For U.S. models

FCC Information for User

CAUTION:

The user changes or modifications not expressly approved by the party responsible for compliance could void the user's authority to operate the equipment.

NOTE:

This equipment has been tested and found to comply with the limits for a Class B digital device, pursuant to Part 15 of the FCC Rules. These limits are designed to provide reasonable protection against harmful interference in a residential installation.

This equipment generates, uses and can radiate radio frequency energy and, if not installed and used in accordance with the instructions, may cause harmful interference to radio communications. However, there is no guarantee that interference will not occur in a particular installation. If this equipment does cause harmful interference to radio or television reception, which can be determined by turning the equipment off and on, the user is encouraged to try to correct the interference by one or more of the following measures:

- Reorient or relocate the receiving antenna.
- Increase the separation between the equipment and receiver.
- Connect the equipment into an outlet on a circuit different from that to which the receiver is connected.
- Consult the dealer or an experienced radio/TV technician for help.

For Canadian Models

NOTE: THIS CLASS B DIGITAL APPARATUS COMPLIES WITH CANADIAN ICES-003.

For models having a power cord with a polarized plug:

CAUTION: TO PREVENT ELECTRIC SHOCK, MATCH WIDE BLADE OF PLUG TO WIDE SLOT, FULLY INSERT.

Modèle canadien

REMARQUE: CET APPAREIL NUMÉRIQUE DE LA CLASSE B EST CONFORME À LA NORME NMB-003 DU CANADA.

Sur les modèles dont la fiche est polarisée:

ATTENTION: POUR ÉVITER LES CHOCS ÉLECTRIQUES, INTRODUIRE LA LAME LA PLUS LARGE DE LA FICHE DANS LA BORNE CORRESPONDANTE DE LA PRISE ET POUSSER JUSQU'AU FOND.

For some models

Before use, connect the appropriate AC plug adapter to the AC adapter.

The type of plug adapter depends on the place of purchase.

Detach

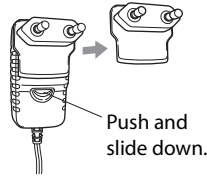

Attach

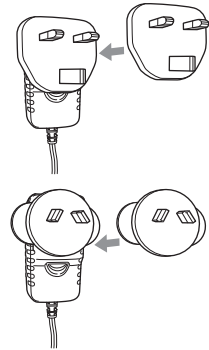

For European Models

Declaration of Conformity

We, ONKYO EUROPE
ELECTRONICS GmbH
LIEGNITZERSTRASSE 6,
82194 GROEBENZELL,
GERMANY



declare in own responsibility, that the ONKYO product described in this instruction manual is in compliance with the corresponding technical standards such as EN60065, EN55013, EN55020 and EN61000-3-2, -3-3.

GROEBENZELL, GERMANY

K. MIYAGI

ONKYO EUROPE ELECTRONICS GmbH

Getting Started

About the RI Dock

With the Onkyo RI Dock, you can easily play the music stored on your Apple iPod/iPhone through your Onkyo audio system and enjoy great sound, and watch iPod/iPhone slide-shows and videos on your TV. In addition, the onscreen display (OSD) allows you to view, navigate, and select your iPod/iPhone model's contents on your TV, and with the supplied remote controller, you can control your iPod/iPhone from the comfort of your sofa. You can even use your Onkyo amp's remote controller to operate your iPod/iPhone.

RI, which stands for Remote Interactive, is an exclusive Onkyo control system that allows all **RI**-capable Onkyo audio components to be turned on or off together, and your amp to turn on automatically and select the appropriate input source when playback is started on a source component. It also allows you to control your iPod/iPhone with your amp's remote controller.

In this manual, the DS-A4 Remote Interactive Dock is referred to as the "RI Dock."

Features

- Compatible iPod/iPhone models Made for:**
 - iPod touch (1st, 2nd, 3rd and 4th generation)
 - iPod classic
 - iPod (4th and 5th generation)
 - iPod nano (1st, 2nd, 3rd, 4th, 5th and 6th generation)
 - iPod mini
 - iPhone 4, iPhone 3GS, iPhone 3G, iPhone
- iPod/iPhone Video Playback**
- Resume Music and Video Playback Function**
- Component video output to television is supported by iPhone 4, iPhone 3GS, iPod nano (3rd generation and later), iPod touch (2nd generation and later), and iPod classic at 480p or 576p resolution;**

and by iPhone 3G, iPhone, and iPod touch (1st generation) at 480i or 576i resolution

- Onscreen Display to Show iPod/iPhone model's contents**
- Dedicated Remote Control Supplied**
- Gold-Plated Audio/Video Outputs**
- Connectable with any Onkyo RI-compatible A/V Systems or Components**
- Remote Control Operability via Onkyo's Remote Interactive (RI) System**
- Recharging Function via AC**
- Available in Black Only**

Notes:

- Before using the RI Dock, update your iPod/iPhone with the latest software, available from the Apple Web site at: www.apple.com
- For the latest information on the RI Dock, see the Onkyo Web site at: www.onkyo.com

Package Contents

Make sure you have the following items:

- **DS-A4 Remote Interactive Dock**



- **AC adapter**



- **AV cable**

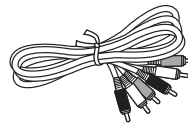

- **RI cable**



- **Component video conversion cable**

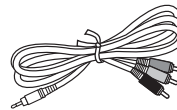

- **Remote controller**



- **Button-type battery (CR 2025)**
- **Instruction manual**

Getting to Know the RI Dock

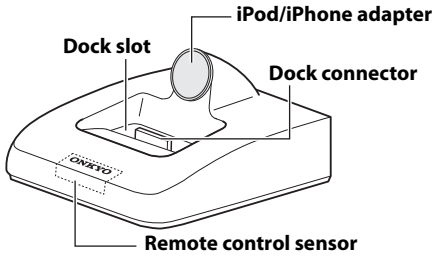

RI MODE switch

Set it to match your amp's input display (see below).

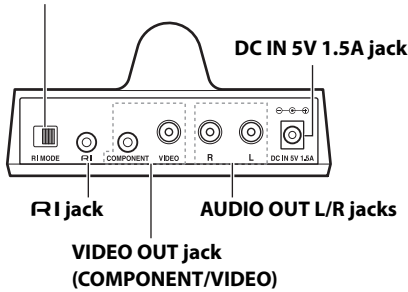

■ Adjusting the iPod/iPhone Adapter

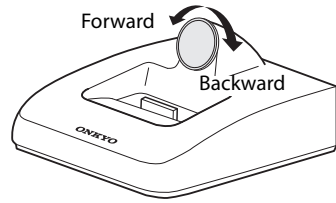

The iPod/iPhone adapter needs to be adjusted to match your particular iPod/iPhone. Insert your iPod/iPhone into the RI Dock. If there's a gap between the back of your iPod/iPhone and the adapter, turn the adapter counterclockwise to close the gap. Turning the adapter counterclockwise moves it forward. Turning it clockwise moves it backward.

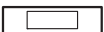

Amp input display

TAPE

HDD or DOCK



RI MODE switch



TAPE DOCK/HDD(OSD)
TAPE



TAPE DOCK/HDD(OSD)
HDD/DOCK

See your amp's instruction manual for details on changing the input display.



To control your iPod/iPhone with your amp's remote controller, select the matching remote control mode.

Amp remote controller's mode

Remote Controller

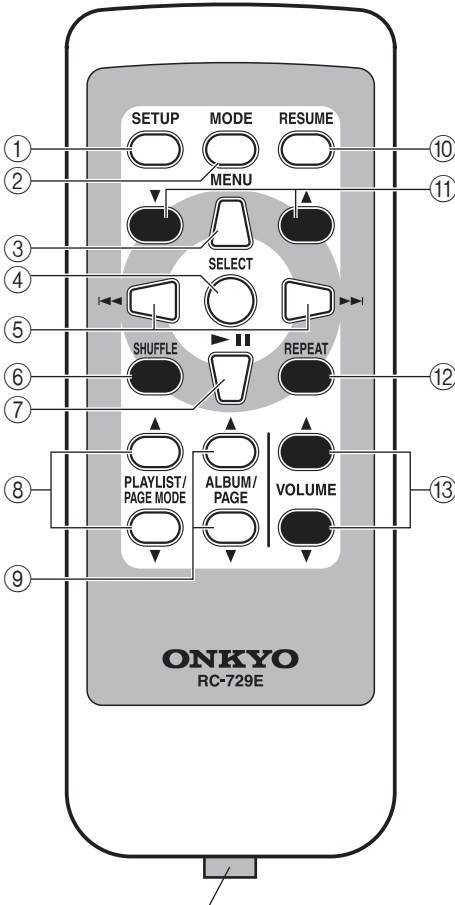

Remove the plastic film before using the remote controller.

① **SETUP button**

Used to set the TV system (PAL/NTSC), video output mode (composite/component) and the remote controller's ID.

② **MODE button**

Sets the OSD mode to On or Off.

③ **MENU button**

Used to switch the function mode between Music mode and Video mode. Used to select the previous menu on the onscreen display and iPod/iPhone.

④ **SELECT button**

Used to select songs/videos and menus on the onscreen display and iPod/iPhone.

⑤ **Previous and Next [◀◀]/[▶▶] buttons**

The Previous [◀◀] button selects the previous track. During playback it selects the beginning of the current track. The Next [▶▶] button selects the next track.

Press and hold the Previous [◀◀] button to rewind. Press and hold the Next [▶▶] button to fast forward.

⑥ **SHUFFLE button (Music mode only)**

Sets the Shuffle function to Songs, Albums, or Off.

⑦ **Play/Pause [▶/||] button**

Starts or pauses playback of the selected song/video.

⑧ **PLAYLIST/PAGE MODE [▲]/[▼] buttons**

Used to select the page modes. During playback or when the OSD mode is set to Off, they select playlists.

⑨ **ALBUM/PAGE [▲]/[▼] buttons**

Used to page through the playlists (artists, albums, songs, genres, composers) displayed on your TV. During playback or when the OSD mode is set to Off, they select albums.

⑩ **RESUME button**

Used to resume playback. It has no function when the OSD mode is set to Off.

⑪ **Up and Down arrow [▲]/[▼] buttons**

Used to navigate songs/videos and menus on the onscreen display and iPod/iPhone. While pressing the SETUP button, they switch the video output mode between Composite mode and Component mode.

⑫ **REPEAT button**

Sets the Repeat function to One, All, or Off.

⑬ **VOLUME [▲]/[▼] buttons**

Adjust the volume on the Onkyo amp or AV receiver. They don't affect the iPod/iPhone model's volume setting.

Replacing the Battery

Use only a battery of the same type (CR 2025).

1. To open the battery compartment, press the small hollow and slide open the cover.

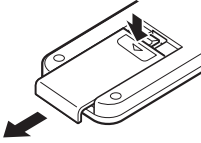

2. While pressing the tab as shown, slide out the old battery.
Slide the new battery into the battery compartment with the positive side facing up.

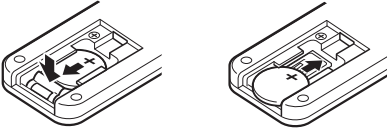

3. Slide the cover shut.

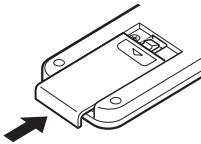

Notes:

- If the remote controller doesn't work reliably, try replacing the battery.
- If you intend not to use the remote controller for a long time, remove the battery to prevent damage from leakage or corrosion.
- An expired battery should be removed as soon as possible to prevent damage from leakage or corrosion.

Caution: Replacing the battery incorrectly may cause an explosion. Use only a battery of the same type or an equivalent.

Aiming the Remote Controller

When using the remote controller, point it toward the RI Dock's remote control sensor, as shown below.

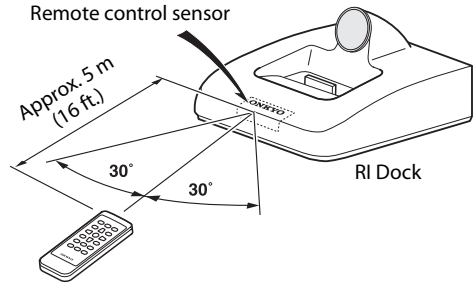

Notes:

- If the RI Dock is placed on top of another component, the remote controller's signal may be obstructed and the remote controller may not work reliably.
- The remote controller may not work reliably if the RI Dock is subjected to bright light, such as direct sunlight or inverter-type fluorescent lights. Keep this in mind when installing.
- If another remote controller of the same type is used in the same room, or the RI Dock is installed close to equipment that uses infrared rays, the remote controller may not work reliably.
- Don't put anything on top of the remote controller, such as a book or magazine, because a button may be pressed continuously, thereby draining the batteries.
- The remote controller may not work reliably if the RI Dock is installed in a rack behind colored glass doors. Keep this in mind when installing.
- The remote controller will not work if there's an obstacle between it and the RI Dock's remote control sensor.

Hooking Up the RI Dock

Depending on the Onkyo amp that you're using, choose connection method **A** or **B**.

- A:** Connect the RI Dock's AUDIO OUT L/R jacks and VIDEO OUT jack to an RI Dock-compatible input on your Onkyo amp. (You might need to change the input display to "HDD" or "DOCK.")
- B:** Connect the RI Dock's AUDIO OUT L/R jacks to the TAPE IN jacks on your Onkyo amp. And connect the RI Dock's VIDEO OUT jack directly to your TV.

See your amp's instruction manual for details.

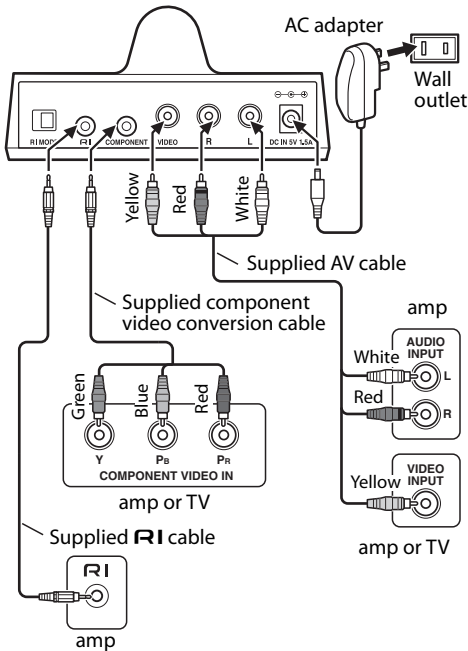

- 1.** Using the supplied AV cable, connect the RI Dock's AUDIO OUT L/R jacks to a suitable audio input on your amp. And connect the RI Dock's VIDEO OUT jack to a video input on your Onkyo amp or TV. If your Onkyo amp or TV has a component video input jack, connect the RI Dock's COMPONENT VIDEO OUT jacks to a component video input jack on your Onkyo amp or TV, using the supplied Component Video

Conversion Cable.

The input you use depends on the type of Onkyo amp you have. See your amp's instruction manual for details.

- 2.** Using the supplied **RI** cable, connect the RI Dock's **RI** jack to an **RI** jack on one of the Onkyo components in your system.
- 3.** Connect the supplied AC adapter to the RI Dock's DC IN jack.

Note: When the AC adapter is unplugged or not connected to the RI Dock, the RI Dock will output no sound or video, **RI** functions will not work, and your iPod/iPhone model's battery will not be charged.

Caution: Connect the supplied **RI** cable to only **RI** jacks. Do not connect headphones to the **RI** jack, as it will damage your equipment.

■ If you've connected the RI Dock's AUDIO OUT L/R jacks to your amp's TAPE IN jacks and also want to connect the RI Dock's VIDEO OUT jack to your amp

Connect the RI Dock's VIDEO OUT jack to an unused video input on your amp.

When you want to watch an iPod/iPhone slide-show or video, select the video input source first, and then select the TAPE input source. Your amp will output the audio being fed to the TAPE input, and because the video source doesn't change when the TAPE input source is selected, it'll continue to output the video being fed to the video input.

■ What to do if you already have a component connected to your amp's TAPE input or RI Dock-compatible input

Connect the RI Dock to an unused AV input on your amp, and select the input source manually.

Using the RI Dock

Setting the OSD Mode

Set the OSD (onscreen display) mode before you start using the RI Dock.

1. Plug in the AC adapter.
2. Turn on your TV and amp, and select the appropriate inputs on your TV and amp.
3. Insert your iPod/iPhone into the



4. Select the video output mode depending on the video connection.
While pressing the remote controller's [SETUP] button, press the Up [▲] button for the component video connection, press the [▼] button for the composite (default) connection.

5. Use the remote controller's [MODE] button to set the OSD mode.



On: Playlists (artists, albums, songs, and so on) are displayed on your TV, and you can navigate and select your music or video while looking at your TV. While this mode is selected, your iPod/iPhone displays the Onkyo logo.

Off: Nothing is displayed on your TV and you navigate and select your contents by using your iPod/iPhone model's display.

Notes:

- To prevent dock connector damage, don't twist your iPod/iPhone when inserting or removing it, and be careful not to knock over the RI Dock while your iPod/iPhone is inserted.
- Don't use the RI Dock with any other iPod/iPhone accessories, such as FM transmitters and microphones, because they may cause a malfunction.
- You can't change the OSD mode while watching an iPod/iPhone slideshow or video.

Controlling Your iPod/iPhone without the OSD

To control your iPod/iPhone without the OSD, set the OSD mode to Off, and use the remote controller as explained on page 6.

Controlling Your iPod/iPhone with the OSD

When the OSD mode is set to On and your iPod/iPhone is inserted in the RI Dock, you can navigate and select your music or video on your TV.

Music Mode

■ Playing Songs

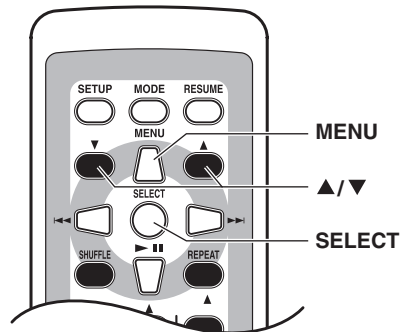

1. Press the remote controller's [MENU] button to select the Music mode.

- Use the Up and Down arrow [▲]/[▼] buttons to select Playlists, Artists, Albums, Genres, Songs or Composers, and then press the [SELECT] button.

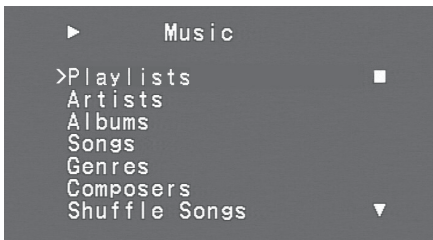

Top Menu

- Use the Up and Down arrow [▲]/[▼] buttons and [SELECT] button to select a song, and press the [SELECT] button to start playback.

When selecting songs, use the [MENU] button to go back to the previous menu.

■ Using the Page Modes

With the page modes, you can quickly locate your favorite songs even when your song lists, artist lists, and so on are very long. There are four page modes: **L**, **M**, **S**, and **P**. These stand for Large, Medium, Small, and Page. In P mode, you can page through the list consecutively. In the S, M, and L modes, you can page through the list in progressively larger steps.

- Use the PAGE MODE Up and Down [▲]/[▼] buttons to select a page mode. Depending on the size of the list, it may not be possible to change the page mode.
- Use the PAGE Up and Down [▲]/[▼] buttons to page up or down the list.



First song on the next page

First song on the previous page

Page mode

Note:

- While playing a playlist, you can use the PLAYLIST Up and Down [▲]/[▼] buttons to select other playlists. While playing an album, you can use the ALBUM Up and Down [▲]/[▼] buttons to select other albums.

■ Song Shuffle

You can play all of the songs in your iPod/iPhone in random order.

- Press the [MENU] button repeatedly to select the music top menu and use the Up and Down arrow [▲]/[▼] buttons to select "Shuffle Songs," and then press the [SELECT] button.

■ Now Playing

During playback, you can display information about the current song.

- Press the [MENU] button repeatedly to select the music top menu and use the Up and Down arrow [▲]/[▼] buttons to select "Now Playing," and then press the [SELECT] button.

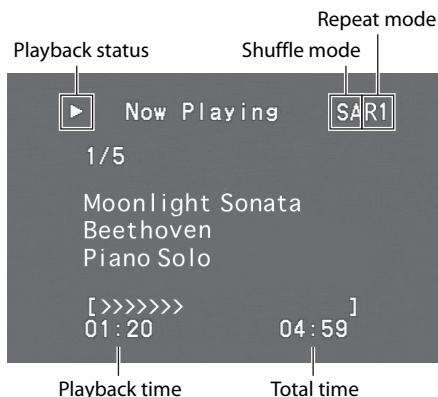

Shuffle modes

S Song shuffle

SA Album shuffle

Repeat modes

R All repeat

R1 One-track repeat

■ Screen Saver

You can set the time at which the screen saver is activated to any one of the following four options: 1 minute, 5 minutes, 10 minutes, or Off (screen saver off).

When the screen saver activates, the onscreen display on your TV disappears. Press any button on the remote controller to cancel the screen saver and resume the onscreen display.

Video Mode

■ Playing Videos

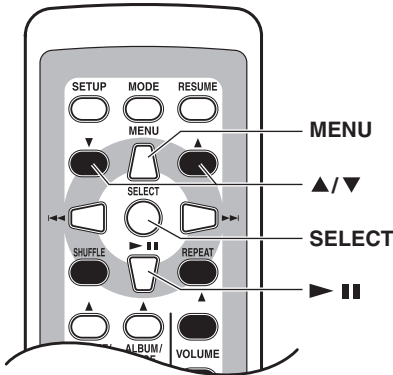

1. Press the remote controller's [MENU] button to select the Video mode.
2. Use the Up and Down arrow [▲]/[▼] buttons to select Movies, Music Videos, TV Shows, Video Podcasts, or Rentals, and then press the [SELECT] button.

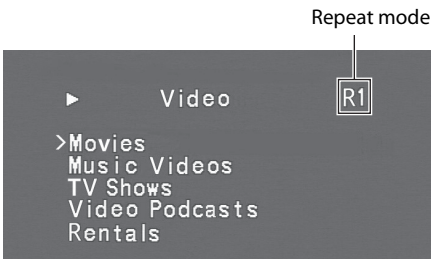

Top Menu

Repeat modes

R All repeat **R1** One-track repeat

3. Use the Up and Down arrow [▲]/[▼] buttons and [SELECT] button to select a video, and press the [SELECT] button to start playback.
When selecting videos, use the [MENU] button to go back to the previous menu.

Resume Function

With the Resume function, you can resume playback of the song/video that was playing when you removed your iPod/iPhone from the RI Dock or changed the OSD mode to Off.

1. Select and play a song/video displayed on your TV.
2. During playback or while playback is paused, remove your iPod/iPhone from the RI Dock or change the OSD mode to Off. The current song/video is remembered.
3. When you reinsert your iPod/iPhone into the RI Dock (set the OSD mode to On), press the [RESUME] button to resume playback of the remembered song/video.

Notes:

- The Resume function can be used only when the OSD mode is set to On.
- If the AC adapter is disconnected, the remembered song/video will be forgotten.
- If the Resume function is used during shuffle playback, when the iPod/iPhone is reinserted in the RI Dock, playback will resume with any song/video.
- The Video Menu is properly displayed only when the language setting on the iPod/iPhone is set to English. Be sure to set the language to English before you use the Video Menu.

Setting the TV System (European model only)

While the OSD mode is set to On, you can set the RI Dock's video output to PAL or NTSC.

If the onscreen display looks distorted on your TV, try changing the TV system.

- While pressing and holding down the [SETUP] button, press the VOLUME Up [▲] button for more than 3 seconds to select NTSC, or press the VOLUME Down [▼] button for more than 3 seconds to select PAL.

Other Functions

■ RI Functions

Depending on your amp and generation of iPod/iPhone, you may also be able to use the following functions.

Note:

- Your amp may take several seconds to startup, so you might not hear the first few seconds of the first song/video.

• System On Function

When you turn on your amp, the iPod/iPhone turns on as well. With some amps, you may need to press the [ON] button on your amp's remote controller's twice to turn on the other components in your system.

• System Off Function

When you turn off your amp, the iPod/iPhone turns off as well.

• Auto Power On Function*

If you start iPod/iPhone playback while your amp is on Standby, your amp will automatically turn on and select your iPod/iPhone as the input source. Then, your iPod/iPhone will start playback.

• Direct Change Function*

If you start iPod/iPhone playback while listening to another input source, your amp will automatically select your iPod/iPhone as the input source.

• Timer Play

You can use your amp's Timer function to turn on your amp and iPod/iPhone and start playback at a specified time.

• Using Your Amp's Remote Controller

You can use your amp's remote controller to control basic iPod/iPhone functions (see page 14).

Operating Notes:

- The RI Dock must be connected to your amp with both an RI cable and an audio cable to use the RI functions.
- If your amp doesn't support the System On, System Off, Auto Power On, and Direct Change functions, you'll need to turn your amp on and off and select the input source manually.
- Before you select another input source, stop iPod/iPhone playback to prevent your amp from selecting the iPod/iPhone input source by mistake.
- If any accessories are connected to your iPod/iPhone, your amp may not be able to select the input source properly.
- While your iPod/iPhone is in the RI Dock, its volume control has no effect. If you adjust your iPod/iPhone model's volume control while it's in the RI Dock, make sure it's not set too high before you reconnect your headphones.

* If you use your iPod/iPhone model's controls to start an iPod/iPhone slideshow or video, these functions will not work, so use the remote controller instead.

■ Using Your iPod/iPhone model's Alarm Clock

You can use your iPod/iPhone model's Alarm Clock function to automatically turn on your iPod/iPhone and amp at a specified time. Your amp's input source will automatically be set to the input to which your iPod/iPhone is connected.

Notes:

- This function only works when the OSD mode is set to Off.
- To use this function, your iPod/iPhone must be in the RI Dock, and the RI Dock must be connected to your amp with both an **RI** cable and an audio cable.
- When you use this function, be sure to set your amp's volume control to a suitable level.
- Your amp may take several seconds to startup, so you might not hear the first few seconds of the first song/video.

■ Charging Your iPod/iPhone model's Battery

The RI Dock charges your iPod/iPhone model's battery while your iPod/iPhone is in the RI Dock.

Notes:

- To charge your iPod/iPhone battery, the AC adapter must be plugged into a suitable wall outlet and connected to the RI Dock's DC IN jack.
- See your iPod/iPhone model's instruction manual for more information on battery charging.

Setting the Remote Controller's ID

If you cannot adjust the volume of your Onkyo component with the DS-A4's remote controller, try changing its remote control ID. The default setting is #1.

Some Onkyo components are set to ID #2 or #3.

- While pressing and holding down the [SETUP] button, press one of the following buttons for more than 3 seconds to set the ID:

ID #1: PLAYLIST Up [▲] button

ID #2: ALBUM Up [▲] button

ID #3: PLAYLIST Down [▼] button

ID #4: ALBUM Down [▼] button

Using Your Amp's Remote Controller

The following table shows which buttons on your amp's remote controller you can use to control your iPod/iPhone while it's in the RI Dock. Be sure to select the appropriate remote mode first, and point your remote controller at your amp. Note that some buttons may be labelled differently, and some remote controllers may not have certain buttons.

iPod/iPhone function	Remote controller button to use		Description
	TAPE mode	HDD mode	
Turn on/off	[STANDBY], [ON]	—	iPod/iPhone is turned on and off.
Play	Play [▶]		Starts playback on the iPod/iPhone. If the iPod/iPhone is not already on, it's turned on automatically.
Pause	Pause [⏸], Stop [⏹]	Pause [⏸]	Pauses iPod/iPhone playback.
Next song	[▶▶], [▶▶▶]	Next [▶▶▶]	Selects the next iPod/iPhone song.
Previous song	[◀◀], [◀◀◀]	Previous [◀◀◀]	Restarts the current iPod/iPhone song. Press it twice to select the previous song.
Fast forward	—	Fast Forward [▶▶▶]	Press and hold to fast forward the iPod/iPhone.
Rewind	—	Rewind [◀◀◀]	Press and hold to rewind the iPod/iPhone.

* To select the next or previous photo in an iPod/iPhone photo slideshow, use the controls on your iPod/iPhone photo.

The following functions can be used with some Onkyo amps.

iPod/iPhone function	Remote controller button to use		Description
	TAPE mode	HDD mode	
Shuffle	[DOLBY MODE]	[RANDOM], [PLAYMODE], [SHUFFLE]	Sets the iPod/iPhone model's Shuffle function to: Songs, Albums, or Off.
Repeat	[REVERSE MODE]	[REPEAT]	Sets the iPod/iPhone model's Repeat function to: One, All, or Off.
Backlight	REC [●]	[DISPLAY], [SCROLL]	The iPod/iPhone model's backlight comes on for 30 seconds.
Next playlist	—	[PLAYLIST UP]	Selects the next playlist on the iPod/iPhone.
Previous playlist	—	[PLAYLIST DOWN]	Selects the previous playlist on the iPod/iPhone.
Next album	—	[ALBUM UP]	Selects the next album on the iPod/iPhone.
Previous album	—	[ALBUM DOWN]	Selects the previous album on the iPod/iPhone.

* Depending on your amp, some buttons may not work as expected.

Troubleshooting

■ There's no sound

- Make sure your iPod/iPhone is actually playing.
- Make sure your iPod/iPhone is inserted properly in the RI Dock.
- Make sure your amp is turned on, the correct input source is selected, and the volume is turned up.
- Make sure the plugs are pushed in all the way.
- Make sure the AC adapter is connected to a suitable wall outlet and connected to the RI Dock.

■ The RI Dock's remote controller doesn't control your iPod/iPhone

- If the RI Dock is placed on top of another component, the remote controller's signal may be obstructed and the remote controller may not work reliably. In this case, try repositioning the RI Dock.
- Make sure your iPod/iPhone is properly inserted in the RI Dock.
- When you use the RI Dock's remote controller, point it toward the RI Dock (see page 7).
- Some of the remote controllers buttons work differently depending on the OSD mode: On or Off (see page 6).

■ Your amp's remote controller doesn't control your iPod/iPhone

- Make sure your iPod/iPhone is properly inserted in the RI Dock.
- If your amp's remote controller has remote mode buttons, make sure you've selected the right mode.
- Check the RI Dock's RI MODE switch setting.
- When you use your amp's remote controller, point it toward your amp.
- The RI Dock must be connected to your amp with both an **RI** cable and an audio cable.
- Make sure the RI Dock's RI MODE switch setting and the remote control mode match this setting. See your amp's manual for more information. If you still can't control your iPod/iPhone, start playback by pressing your iPod/iPhone model's Play button. Remote operation should then be possible.
- Make sure your amp's remote controller is set to the correct remote control ID.

■ The onscreen display doesn't appear on your TV

- Set the OSD mode to On (see page 9).
- Try setting the TV system to PAL or NTSC (see page 12).
- Select the video output mode (composite/component) according to the video input on your TV (see page 9).

■ To watch an iPod/iPhone slideshow or video on TV

- Set the OSD mode to Off, and use your iPod/iPhone model's controls or remote controller to select and start the slideshow or video.
- To control the slideshow, follow standard iPod/iPhone operating procedures.

Specifications

Power supply:	AC adapter (5 V DC)
Power consumption (iPod/iPhone not inserted):	North American model: 0.8 W Other models: 0.8 W
Weight:	0.66 lbs. (300 g)
Dimensions (W x H x D):	4-5/16 x 2-1/8 x 4-7/16 inches 110 x 54 x 112 mm
Connectors:	VIDEO OUT (COMPONENT/VIDEO) AUDIO OUT L/R RI jack

Specifications and features are subject to change without notice.

In catalogs and on packaging, the letter at the end of the product name indicates the color. Specifications and operation are the same regardless of color.

- The operating instructions in this manual may change with future upgrades to the iPod/iPhone software.
- The AC adapter supplied with the RI Dock is designed exclusively for use with the RI Dock. Do not use it with another device. Likewise, do not use any other AC adapter with the RI Dock. Doing so may damage the RI Dock.
- If there's any noise when listening to an FM or AM radio station on your tuner or receiver, try moving its antenna away from the RI Dock, iPod/iPhone, and AC adapter's cable. In addition, don't wrap the AC adapter's cable around any other cables.

ONKYO®

ONKYO SOUND & VISION CORPORATION

2-1, Nisshin-cho, Neyagawa-shi, OSAKA 572-8540, JAPAN
Tel: 072-831-8023 Fax: 072-831-8163

ONKYO U.S.A. CORPORATION

18 Park Way, Upper Saddle River, N.J. 07458, U.S.A.
Tel: 800-229-1687, 201-785-2600 Fax: 201-785-2650 <http://www.us.onkyo.com/>

ONKYO EUROPE ELECTRONICS GmbH

Liegnitzerstrasse 6, 82194 Groebenzell, GERMANY
Tel: +49-8142-4401-0 Fax: +49-8142-4401-555 <http://www.eu.onkyo.com/>

ONKYO EUROPE ELECTRONICS GmbH (UK BRANCH)

The Coach House 81A High Street, Marlow, Buckinghamshire, SL7 1AB, UK
Tel: +44-(0)1628-473-350 Fax: +44(0)-1628-401-700

ONKYO CHINA LIMITED

Unit 1&12, 9/F, Ever Gain Plaza Tower 1, 88, Container Port Road, Kwai Chung,
N.T., Hong Kong Tel: 852-2429-3118 Fax: 852-2428-9039
<http://www.ch.onkyo.com/>

SN 29400617A

(C) Copyright 2010 ONKYO SOUND & VISION CORPORATION Japan.
All rights reserved.



* 2 9 4 0 0 6 1 7 A *

11012-2